



MILESTONE 6200HR

TREADMILL

# OWNER'S MANUAL

Model Name MS6200HR

Serial Number \_\_\_\_\_

Purchase Date \_\_\_\_\_

Write down for future reference.

Keys Technical Service, (888) 340-0482

*KEYS* Fitness Products, LP

P.O. Box 551239

Dallas, Texas 75239

**keysfitness**  **com**

PART# 15-0108

# Table of Contents



Information	Page #
Table of Contents	2
Specification Sheet	3
Important Safety Information	4
Before You Start	5
Warm Up Exercises	6
Assembly, Moving Instructions	7
Power Requirements	8
Console Functions and Descriptions	9
Program and Operating Instructions	10, 11, 12, & 13
Program Descriptions and Profiles	14
Belt Adjustments and Tension	15
Change to MPH or Km/H	16
Troubleshooting Guide	17
Parts and Diagrams	18
Parts List	19
Warranty Registration (Mail In Form)	20

◆Horsepower (Continuous)	2.5hp
◆Display Type	5 Window LED <i>With green pace display</i>
◆Electronics	One touch
◆Pre-Set Programs	4
◆Semi-Custom Programs	8
◆User Programs	2
◆Heart Rate Program	1
◆Heart Rate Interactive	Yes
◆Power Incline	12%
◆Roller Diameter	2.5"
◆Cushioned Deck	Yes
◆Speed Range	0-10mph
◆Belt Size	20 x 60"
◆Front Hand Rails	Yes
◆Side Hand Rails	Yes
◆Foot Print	29 x 71"
◆Warranty Motor	10 Years
◆Warranty Parts	2 Years
◆Warranty Labor	1 Year
◆Warranty Frame	Lifetime

- 1) **WARNING!** Before using this treadmill or starting any exercise program, consult your physician. This is especially important for persons over the age of 35 and/or persons with pre-existing health problems. The manufacturer or distributor assumes no responsibility for personal injury or property damage sustained by or through the use of this product.
- 2) **WARNING!** To reduce the risk of electrical shock, burns, fire, or other possible injuries to the user, it is important to review this manual and the following precautions *before* operation.

## SAFETY PRECAUTIONS AND TIPS

- ◆ It is the owner's responsibility to ensure that all users of this treadmill have read the Owner's Manual and are familiar with warnings and safety precautions.
- ◆ This treadmill has a user maximum capacity of 350 pounds.
- ◆ The treadmill should only be used on a level surface and is intended for indoor use only. The treadmill should not be placed in a garage, patio, or near water and should never be used while you are wet. KEYS recommends a treadmill mat be placed under the treadmill to protect floor or carpet and for easier cleaning.
- ◆ Follow safety information in regards to plugging in your treadmill. Keep the power cord away from the incline wheels and do not run the power cord underneath your treadmill. Do not operate the treadmill with a damaged or frayed power cord.
- ◆ Wear comfortable, good-quality walking or running shoes and appropriate clothing. Do not use the treadmill with bare feet, sandals, socks or stockings.
- ◆ Always straddle the belt and allow it to start moving before stepping onto the belt.
- ◆ Hold on to handrails when adjusting speed, incline, or other controls.
- ◆ Always examine your treadmill before using to ensure all parts are in working order.
- ◆ Allow the belt to fully stop before dismounting.
- ◆ Pets should never be allowed near or on the treadmill.
- ◆ Do not leave children unsupervised near or on the treadmill.
- ◆ Never operate the treadmill where oxygen is being administered, or where aerosol products are being used.
- ◆ Never insert any object or body parts into any opening.
- ◆ For safety and to prevent damage to your treadmill, no more than one person should use the treadmill at a time.
- ◆ Always unplug the treadmill before cleaning and/or servicing. Service to your treadmill should only be performed by an authorized service representative, unless authorized and/or instructed by the manufacturer. Failure to follow these instructions will void the treadmill warranty.
- ◆ Never leave the treadmill unattended while it is running.

Thank you for purchasing a KEYS treadmill! This quality product you have chosen was designed to meet your needs for cardiovascular exercise.

Before you start, please read the Owner's Manual and become familiar with the operation of your new treadmill.

- ◆ **Remember to take the time to perform the stretching exercises provided to avoid injury.**
- ◆ Do not stand on the walking belt while pressing the Power button or Start/Stop button.
- ◆ Always adjust the speed of the treadmill in small increments as this treadmill is capable of high speeds.
- ◆ If you are taking medication, consult your physician to see if the medication will affect your exercise heart rate.
- ◆ If you have heart problems, you are not active, and/or are over the age of 35 years, do not use the pre-set treadmill programs or start an exercise program without first contacting and receiving approval from your physician.
- ◆ To avoid the risk of electrical shock, always keep the console dry. Do not spill liquids on the console. KEYS recommends a sealed water bottle for beverages consumed while using the treadmill.
- ◆ **Please review the following drawing below to familiarize yourself with the listed parts. This manual covers several treadmills, so the one pictured below may not be identical to your particular model.**

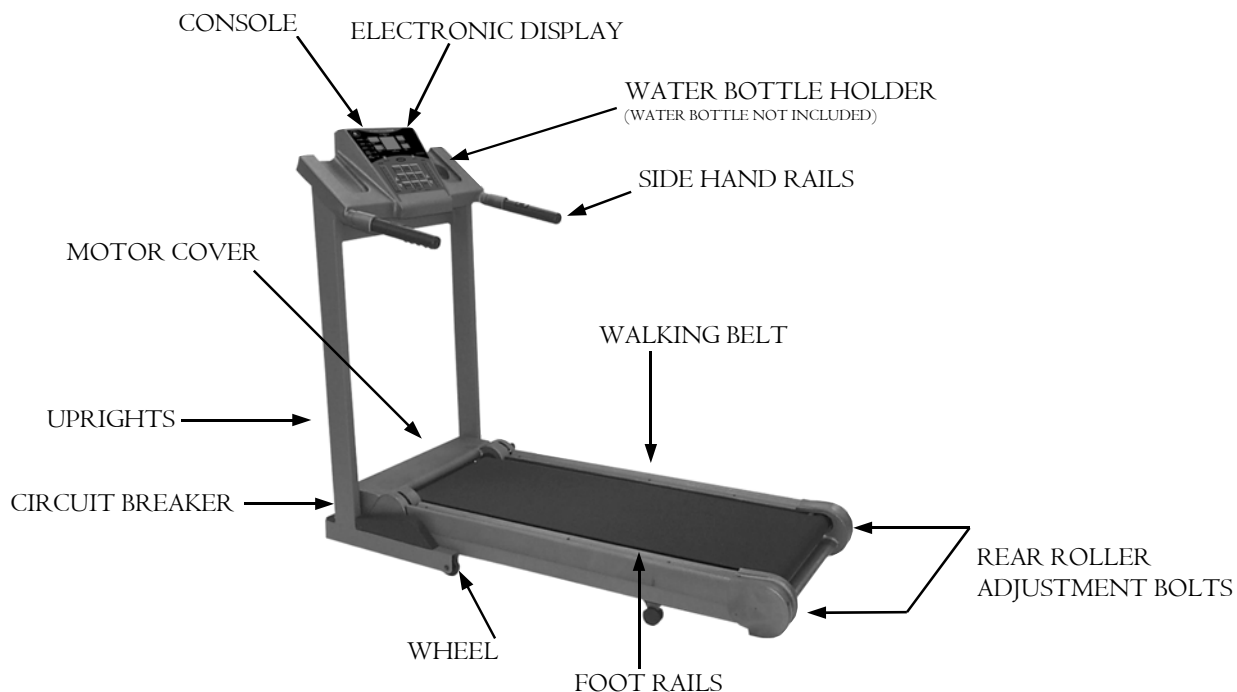

## EXERCISE GUIDELINES

**WARNING!** Before beginning this or any exercise program, you should consult your physician. This is especially important for individuals over the age of 35 or individuals with pre-existing health problems.

Warming up prepares the body for the exercise by increasing circulation, supplying more oxygen to the muscles and raising body temperature. Begin each workout with 5 to 10 minutes of stretching and light exercise to warm up. The photos on this page show several forms of basic stretching you may perform before your workouts. In order to achieve an adequate warm-up, perform each stretch three times.

### TOE TOUCH STRETCH

Stand bending your knees slightly and slowly bend forward from your hips. Allow your back and shoulders to relax as you reach down toward your toes as far as possible. Hold for 15 counts, then relax. This will stretch your hamstrings, back of knees, and back.



### HAMSTRING STRETCH

Sit with one leg extended. Bring the sole of the opposite foot toward you and rest it against the inner thigh of your extended leg. Reach toward your toes as far as possible. Hold for 15 counts, then relax. This will stretch your hamstrings, lower back, and groin.



### CALF/ACHILLES STRETCH

With one leg in front of the other, reach forward and place your hands against a wall. Keep your back leg straight and your back foot flat on the floor. Bend your front leg, lean forward and move your hips toward the wall. Hold for 15 counts, then relax. To cause further stretching of the Achilles tendon, bend your back leg as well. This will stretch your calves, Achilles tendons, and ankles.



### QUADRICEPS STRETCH

With one hand against a wall for balance, reach back and grasp one foot with your other hand. Bring your heel as close to your buttocks as possible. Hold for 15 counts, then relax. This will stretch your quadriceps and hip muscles.



### INNER THIGH STRETCH

Sit with the soles of your feet together and your knees outward. Pull your feet toward your groin area as far as possible. Hold for 15 counts, then relax. This will stretch your quadriceps and hip muscles.

KEYS treadmills are shipped in one piece to make assembly easy. After opening the box, remove any packing materials from the treadmill. You should find a rear endcap (large plastic piece that fits over the rear roller area), and owner's manual packet with bolts and screws for assembly. Do not throw away any packing materials until the unit is working properly. Place the base on a clean, level surface. Make sure the electrical cord will easily reach an electrical outlet.

## Figure 1 – Assembly for main uprights

- 1) Have a second person raise the console to the upright position and hold.
- 2) Insert 3/4" Button Head Bolt into upright bracket and tighten loosely. Repeat for opposite side.
- 3) Insert the TUBE SPACER inside the upright frame and line up with the bottom hole. Hold tube spacer while inserting the 1 1/2" Button Head Bolt and lightly tighten. Repeat for opposite side.
- 4) After completing opposite side, tighten all four assembled bolts and the two other button head bolts that were present before starting. Assembly is now complete.
- 5) Be sure to insert the SAFETY KEY before turning the power on.

## Figure 2 – Assembly for rear end cap

To attach the rear end cap:

- 1) Place plastic rear end cap over exposed rear roller area.
- 2) Align holes in plastic end cap with pre-drilled holes in frame.
- 3) Loosely tighten each screw until all four screws are lined up.
- 4) Tighten all four screws snugly.

## **CAUTION: DO NOT OPERATE TREADMILL WITHOUT SECURING REAR ROLLER HOUSING!!!**

Be sure the treadmill is level to the floor. The rear feet can be adjusted to level the treadmill. Assembly is now complete!

Figure 1

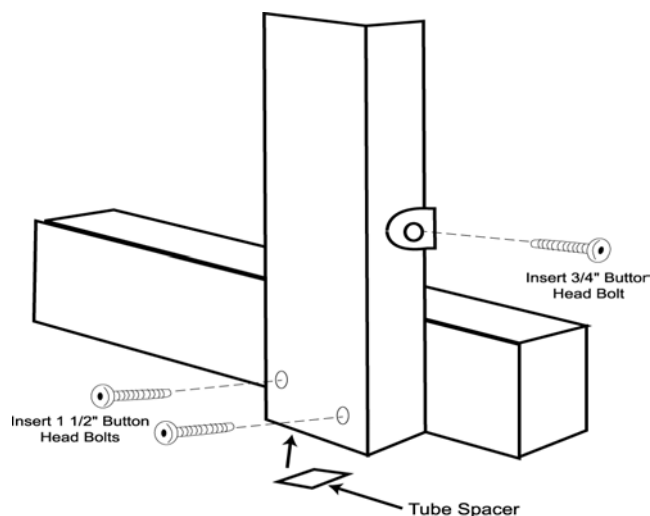
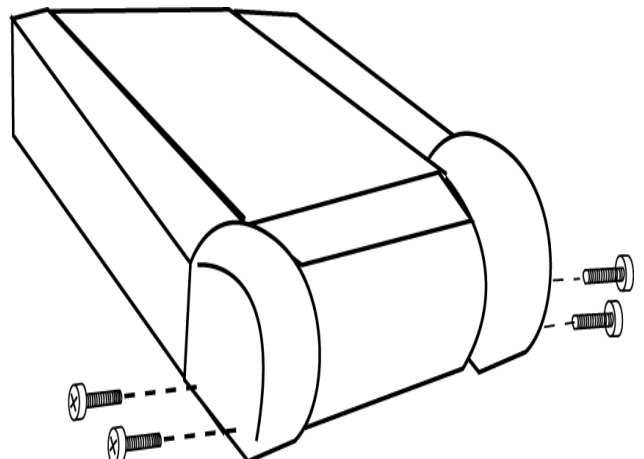

Figure 2



IMPROPER CONNECTION OF THE EQUIPMENT GROUNDING CONNECTOR CAN RESULT IN A RISK OF AN ELECTRIC SHOCK. CHECK WITH A QUALIFIED ELECTRICIAN OR SERVICE MAN IF YOU ARE IN DOUBT AS TO WHETHER THE PRODUCT IS PROPERLY GROUNDING. DO NOT MODIFY THE PLUG PROVIDED WITH THE PRODUCT IF IT WILL NOT FIT THE OUTLET. HAVE A PROPER OUTLET INSTALLED BY A QUALIFIED ELECTRICIAN.

This treadmill can be seriously damaged by sudden voltage changes in your home's electrical power. Voltage spikes, surges, and noise interference can result from weather conditions or from other appliances being turned on or off. To reduce the possibility of treadmill damage, always use a surge protector (not included) with your treadmill.

Surge protectors can be purchased at most hardware stores. The manufacturer recommends a single outlet surge protector with UL 1449 rating as a Transient Voltage Surge Suppressor (TVSS) with UL suppressed voltage rating of 400V or less and an electrical rating of 120VAC, 15 amps.

This treadmill must be grounded to reduce the risk of electrical shock. Grounding provides a path of least resistance for electric current should the treadmill malfunction. This treadmill comes with an electrical cord with an equipment-grounding conductor and a grounding plug. Always plug the power cord into a surge protector, and plug the surge protector into an appropriate outlet that is properly installed and grounded in accordance with all local codes and ordinances.

This product is for use on a nominal 120-volt circuit and has a grounding plug that looks like the plug illustrated in the drawing below.

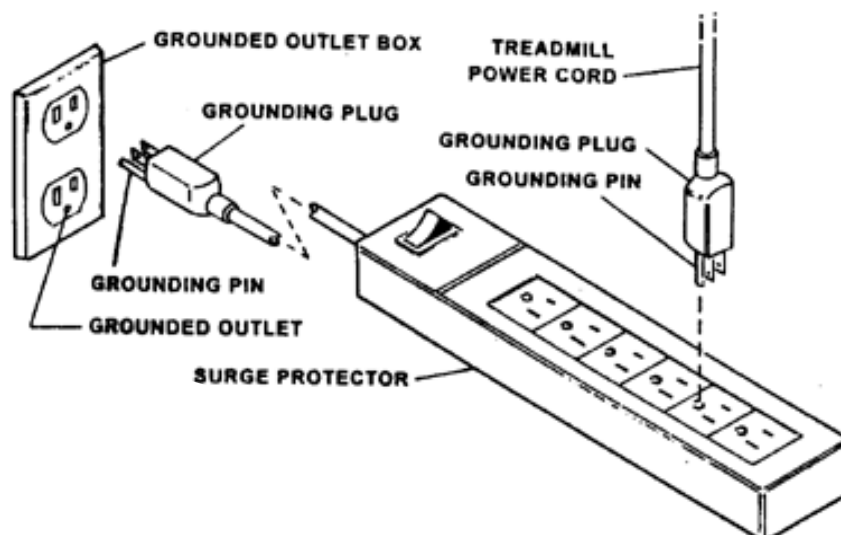



There are five display windows on the control panel to provide feedback information.

## WORKOUT TIME/PACE WINDOW

- ◆ **TIME:** Indicates elapsed time after pressing start in minutes and seconds (0-99 minutes, 0-59 seconds)
- ◆ **INTERVAL TIME:** Indicates countdown in seconds to the next interval starting at 5 seconds and counting to 0 seconds
- ◆ **PACE:** Indicates amount of time required to complete 1 mile at current speed.

## SPEED WINDOW

- ◆ **SPEED:** Indicates MPH (miles per hour) or KMH (kilometer per hour) in .1 increments

## DISTANCE / CALORIES WINDOW

- ◆ **DISTANCE:** Indicates Miles or Kilometers traveled in .01 increments up to 9.99 and .1 increments starting at 10.0
- ◆ **CALORIES:** Indicates estimated calories used based on 150 lb. person at the indicated speed, incline, and time

## INCLINE WINDOW

- ◆ **INCLINE:** Indicates incline in percent of grade 0-12% in 0.5 increments

## CENTER BRICKYARD WINDOW

- ◆ Displays quarter mile track in Manual mode. Indicates position on track by a blink. In program mode, shows the change in speed profile across the interval range (1-10) and shows position with a blinking action.

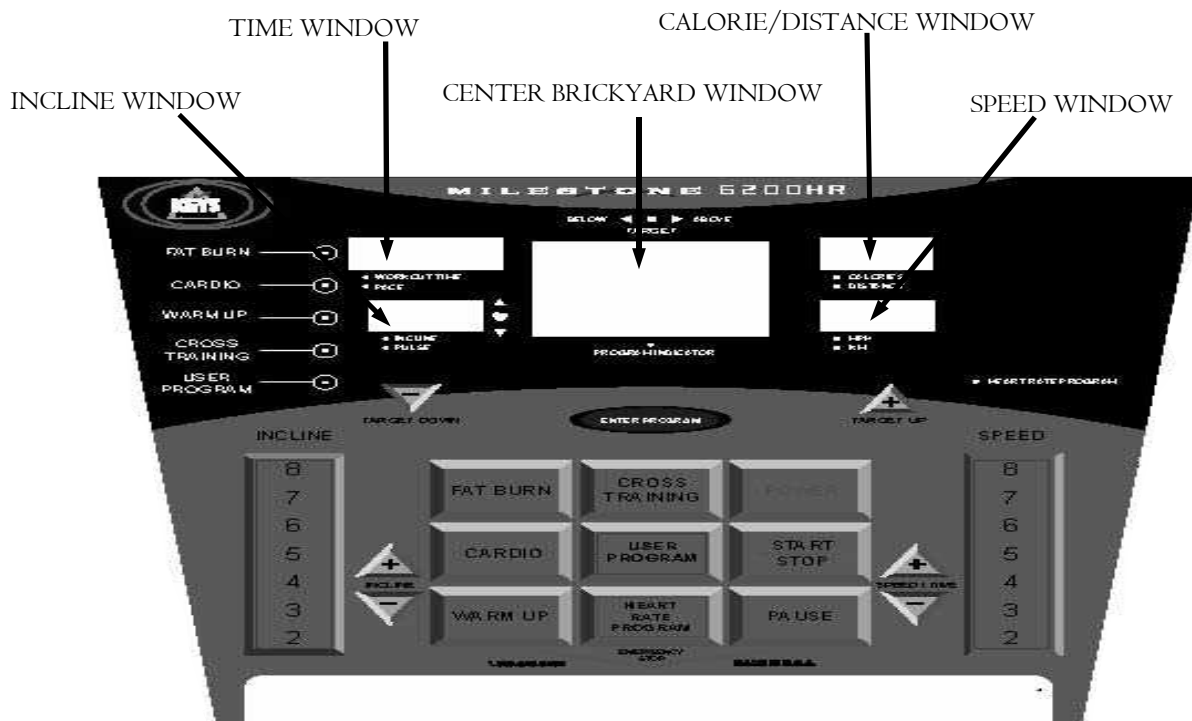

- ◆ QUICK START / MANUAL MODE
- ◆ Plug into a surge protector outlet. Insert the **Safety Key** into the treadmill console.
- ◆ Stand on the treadmill and straddle belt. Attach safety key clip to your clothes.
- ◆ Press POWER button. There will be an eight (8) second delay after pressing the POWER button before data can be entered. The TIME window will flash.
- ◆ Press START/STOP button. Belt will begin to move after 4 seconds. Step on belt slowly after the belt starts moving. Speed or incline may be adjusted by using the appropriate + (increase) or – (decrease) button.
- ◆ To end your workout, press START/STOP button. Belt will gradually slow to zero.
- ◆ To pause your workout, press PAUSE.
- ◆ To re-start after pausing: Press the PAUSE button. **WARNING: THE TREADMILL BELT WILL RESUME AT THE SPEED THE TREADMILL WAS MOVING BEFORE PAUSING.**
- ◆ **Countdown Time, Preset Speed and/or Incline:** Time, Speed, and Incline may be preset prior to getting started. After pressing the POWER button, the time window will blink. Use the SPEED/TIME + or – arrows to select your workout time, then press the ENTER PROGRAM button. The SPEED/TIME window will now be flashing. Using the same + or – arrows, select the speed for your workout, then press ENTER PROGRAM. Now the INCLINE window will be flashing. Use the INCLINE + or – arrows to set your workout incline, then press ENTER PROGRAM. To start, press the START/STOP button.

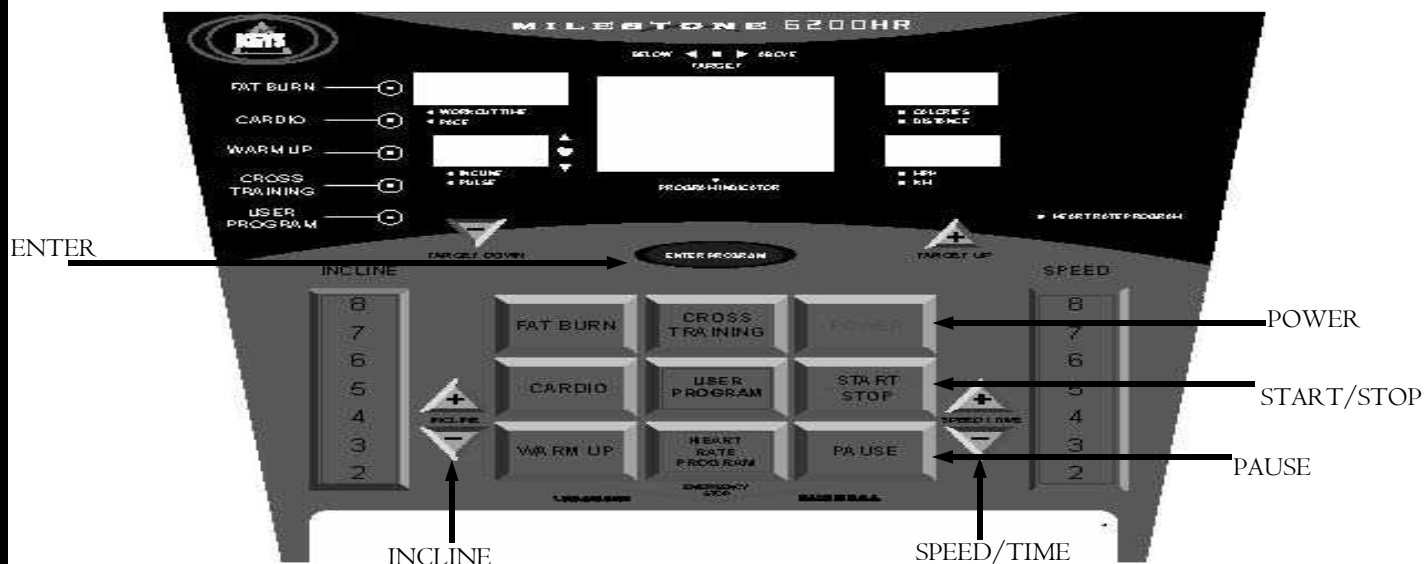

## PROGRAM MODE

Plug treadmill into a surge protector outlet . Insert the **Safety Key** into the treadmill console.

- ◆ Stand on the treadmill and straddle belt. Attach safety key clip to your clothes.
  - ◆ Press **POWER** button. There will be an eight (8) second delay before data can be entered. The **TIME** window will flash.
  - ◆ There are four (4) pre-set and eight (8) semi-custom pre-set programs on the MS6200HR. The treadmill includes **FAT BURN**, **CARDIO**, **WARM-UP**, and **CROSS TRAINING** programs. Select the program by pressing the appropriate button.
  - ◆ Press **START/STOP** button. Belt will begin to move after 4 seconds. Step on belt slowly after the belt starts moving.
  - ◆ **CUSTOMIZING PROGRAMS in P1 and P2 Mode:** Each pre-set program(Fat Burn, Cardio, Warm-up, Cross Training) can be customized in the P1 or P2 mode. After making the program selection, the Calorie window will read “OP”. The “OP” refers to “original program” and is preset. The program name you select will display in the diode light beside the program name. Press the same program button once more and the Calorie window will read P1. The “P1” mode is now accessed. You can now program the Time, Speed, and Incline in P1 mode, which will be saved for future workouts.
    - 1) The **TIME** window will blink. Use the **SPEED/TIME +** or **-** arrows to select your workout time. Press **ENTER PROGRAM**.
    - 2) The **SPEED/TIME** window will then blink. Use the same **+** or **-** arrows to select the speed for your workout. Press **ENTER PROGRAM**.
    - 3) The **INCLINE** window will then blink. Use the **INCLINE +** or **-** arrows to set your workout incline. Press **ENTER PROGRAM**.
- To start, press the **START/STOP** button. To access P2 mode, press the selected program button three times (once for OP, twice for P1, three times for P2). Follow the above steps 1-3 to customize P2 settings.
- ◆ **TO CHANGE A PREVIOUSLY PROGRAMMED P1, P2, or user program:** Once you have programmed the P1 or P2 modes, you will need to use the **PAUSE** button to change the program you previously entered. For instance to change to a new setting in P1-FAT BURN, press the **FAT BURN** button twice to access P1. Then press the **PAUSE** button to get the **TIME** window to flash. Follow the directions above to continue to change the program.

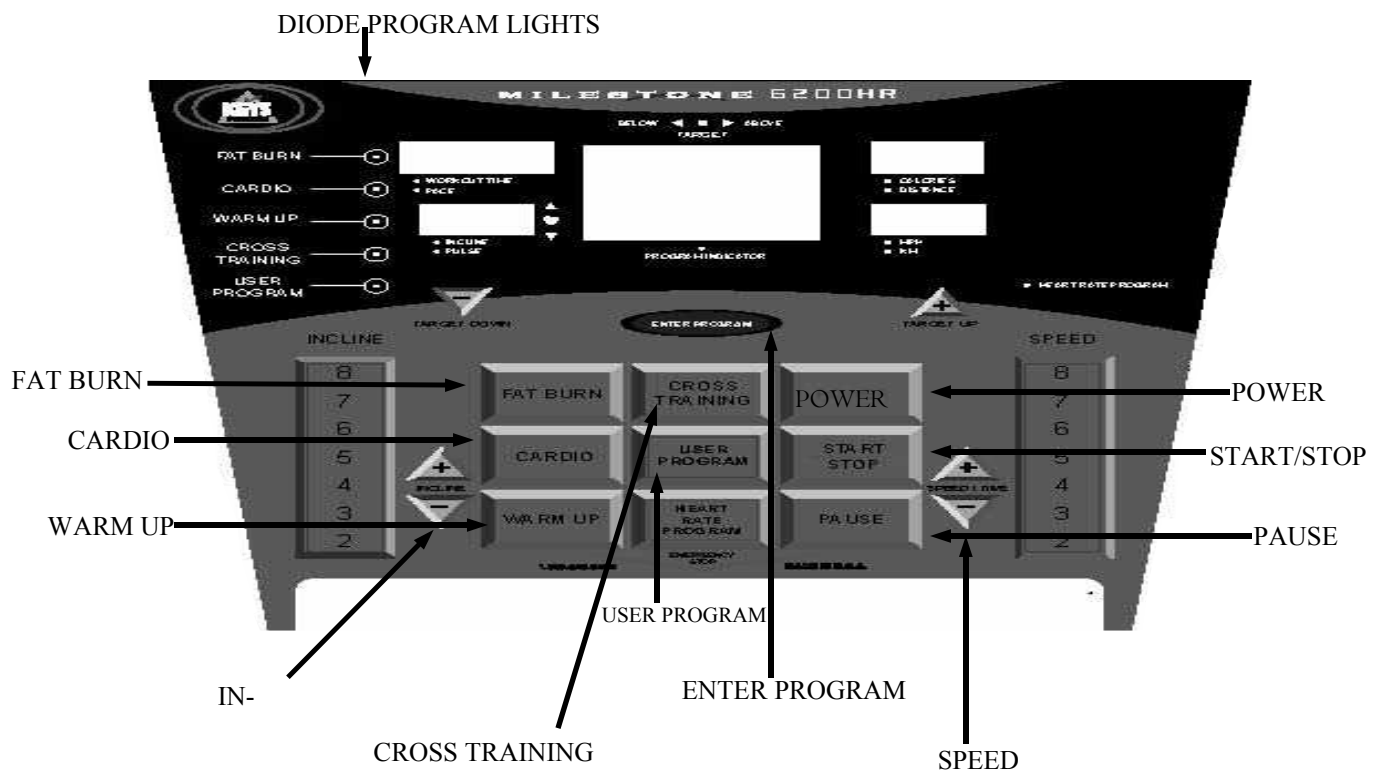

See page 13 for pictures and diagrams

## HEART RATE MONITOR MODE

The treadmill may at any time be used in the Heart Rate Monitor Mode. If the signal from the chest strap is detected, heart rate BPM will be displayed in the INCLINE window. The incline will only be briefly displayed if manual or program changes are initiated. The Heart Rate program is designed to keep your heart at a desired amount of “beats per minute” by automatically adjusting the incline. For example, you have programmed in a desired heart rate of 125 BPM and your heart rate is only at 110 BPM. If you are wearing the Heart Rate Transmitter, correctly the incline will automatically increase to intensify the work load, causing your heart rate to slowly climb to 125 BPM. The treadmill will attempt to maintain your target heart rate through adjustments to the incline for the remainder of your workout. In the same respect, if your heart rate is above your programmed amount of BPM’s, the incline will automatically decrease to lower your heart rate. You may at any time during the Heart Rate Program adjust/override the speed and/or the incline by simply pressing the correct corresponding button. You may also change your “Target Heart Rate” at any time by pressing the TARGET UP or TARGET DOWN button.

## HEART RATE PROGRAM OPERATION

- ◆ Plug treadmill into a surge protector outlet. Insert the **Safety Key** into the treadmill console.
- ◆ Stand on the treadmill and straddle belt. Attach safety key clip to your clothes.
- ◆ Press POWER button. Place the Heart Rate Transmitter strap across your chest and connect ends. (Make sure your skin is moist and the strap is snug for accurate transmission). At this time, if the display is receiving a signal from the chest strap, the incline window will begin to settle on your current heart rate.
- ◆ Press the HEART RATE CONTROL button to enter the electronics into the Heart Rate Program. The incline window will momentarily flash ‘125’, which is the default program target heart rate.
- ◆ The TIME window will blink. Use the SPEED/TIME + or – arrows to select your workout time. Press ENTER PROGRAM.
- ◆ The SPEED/TIME window will then blink. Use the same + or – arrows to select the speed for your workout. Press ENTER PROGRAM.
- ◆ The incline window (if receiving your heart rate accurately) will show current BPM, and the small red light labeled PULSE adjacent to the incline window, will be illuminated. (If the receiver is not receiving an accurate reading, the incline window will be flashing - - - -).
- ◆ To adjust the pre-set target heart rate press the TARGET +/TARGET- button then press the ENTER PROGRAM button.
- ◆ Press START/STOP button. Belt will begin to move after 4 seconds. Step on belt slowly after the belt starts moving.
- ◆ Press START/STOP button. Belt will begin to move after 4 seconds. Step on belt slowly after the belt starts moving.

The small light at the top of the console labeled TARGET will be illuminated if you are at your target. If you are not, the arrow shaped lights will illuminate and reflect if you are above or below your goal. If you are not within 25 BPM of your “Target heart rate” the program will not work. **DO NOT STOP TO START OVER.** Continue exercising and your heart rate will naturally increase. The program will continually monitor your heart rate and periodically adjust the incline up or down to increase or decrease the resistance thereby keeping you at your target zone. At the conclusion of the programmed time the TIME window will flash 00:00 and the CALORIES/DISTANCE window will continue to accumulate values. The treadmill will continue operation until the START/STOP button or the PAUSE button is pressed. Press the POWER button to turn off the treadmill.

## EXERCISE TARGET ZONE CHART

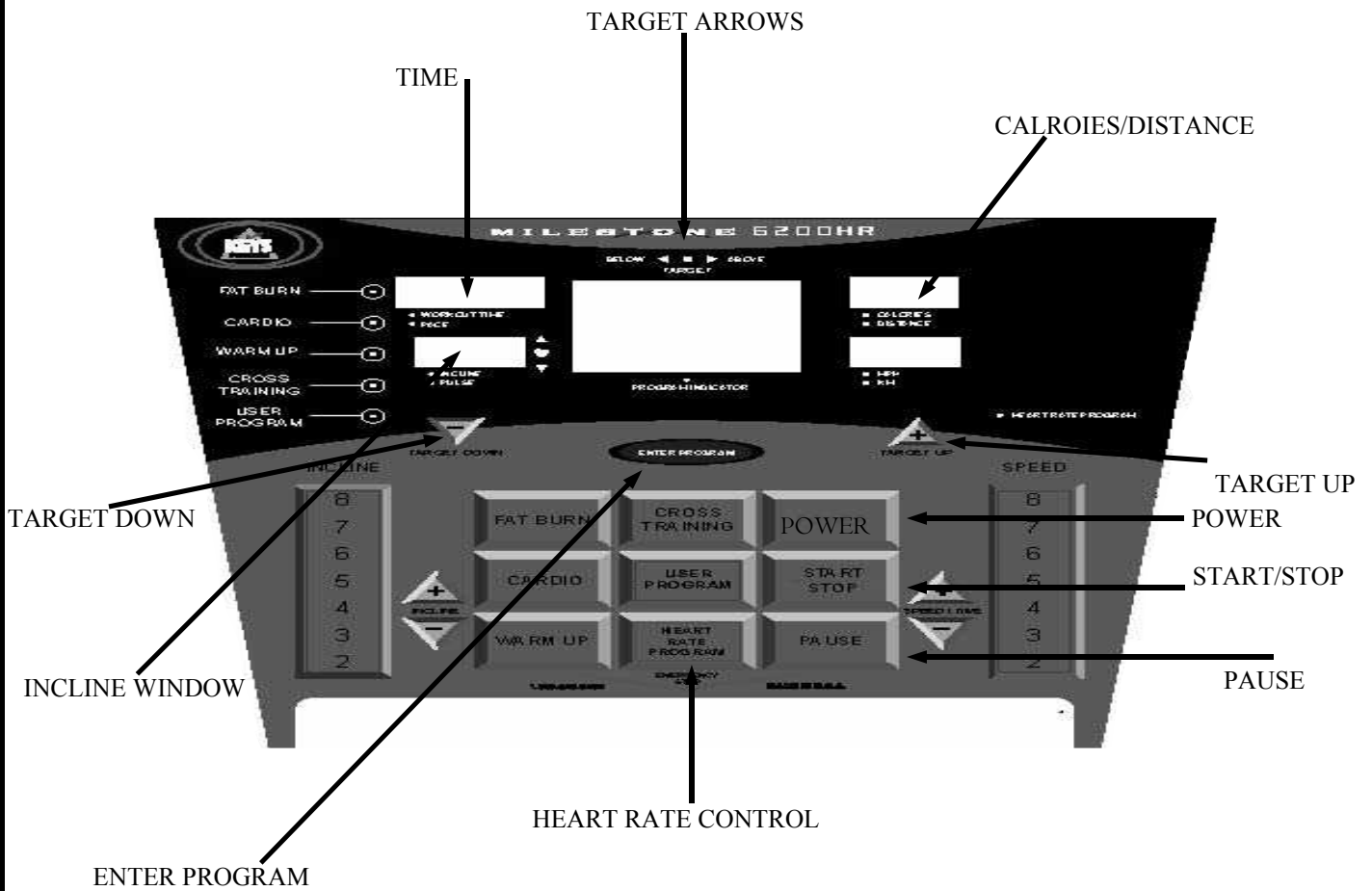
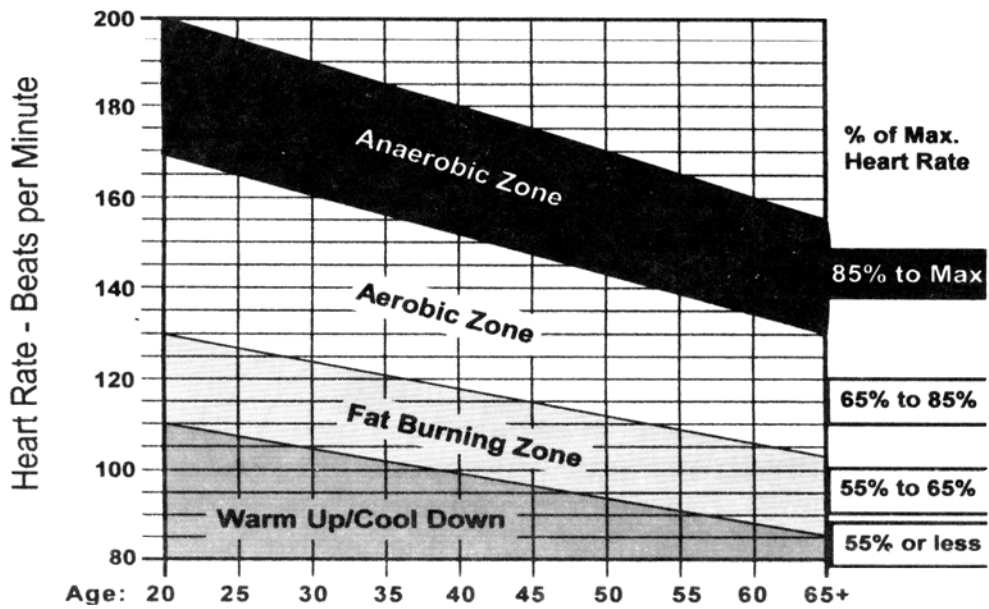

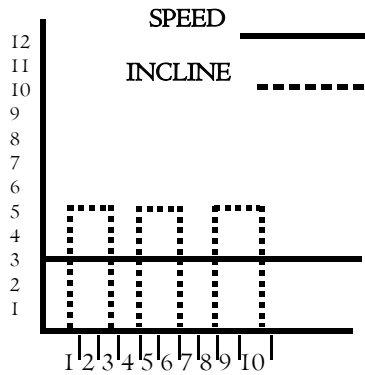

The **Fat Burn Program** is designed to vary the treadmill elevation, while maintaining a constant walking belt speed.

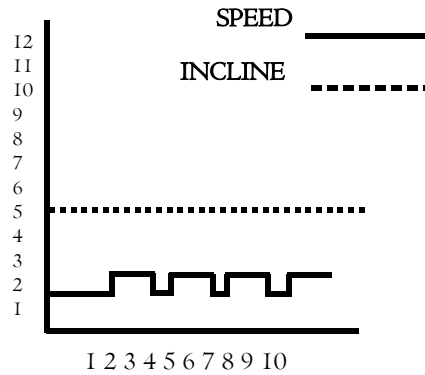

The **Cardio Program** is designed to vary the treadmill Speed, while maintaining a constant Elevation.

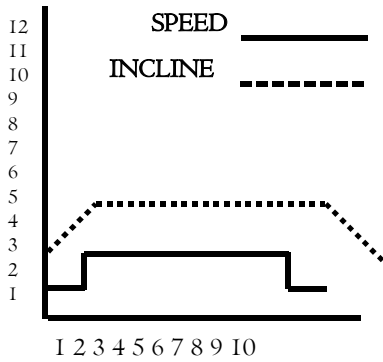

The **Warm Up Program** is designed to gradually increase the treadmill Speed and Elevation in the first segment (warm up) and gradually decrease the treadmill Speed and Elevation in the last segment (cool down). This is also known as a Plateau program.

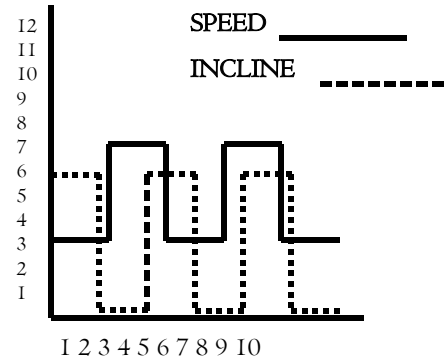

The **Cross Training Program** is designed to control the walking belt speed and elevation inversely in alternating segments.

**WARNING! Do not overtighten rollers! This will cause premature roller bearing failure!**

Belt adjustment and tension performs two functions: adjustment for tension and centering. Your new treadmill comes pre-adjusted from the factory for tension and centering. Please follow the procedures below if the belt shifts to the left or right while walking:

## **WALKING BELT IS SHIFTING TO THE LEFT (Diagram 1)**

First, turn treadmill on to run at 1 mph. Using the hex key provided, turn the left rear roller adjustment bolt  $\frac{1}{4}$  turn in the clockwise direction. Next, run the treadmill at 2.5 mph. You should see the belt start to correct itself by moving back towards the center. Repeat the above procedure until the walking belt is centered. It may be necessary to set walking belt tension once you have completed this procedure if the belt feels like it is slipping while walking. Refer below to the “Walking Belt Slipping” instructions.

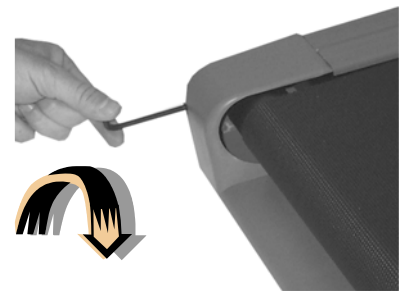

## **WALKING BELT IS SHIFTING TO THE RIGHT (Diagram 2)**

First, turn the treadmill on to run at 1 mph. Using the hex key provided, turn the right rear roller adjustment bolt  $\frac{1}{4}$  turn in the clockwise direction. Next, run the treadmill at 2.5 mph. You should see the belt start to correct itself, moving back towards the center. Repeat the above procedure until the walking belt is centered. It may be necessary to set walking belt tension once you have completed this procedure if the belt feels like it is slipping while walking. Refer below to the “Walking Belt Slipping” instructions.



## **WALKING BELT IS SLIPPING DURING USE (Diagram 3)**

First, unplug the power cord from the surge protector. Using the hex key provided, turn both left and right rear roller adjustment bolts the same distance, usually a  $\frac{1}{4}$  turn in the clockwise direction. Plug the power cord back into the surge protector and run the treadmill at 2.5 mph. You should now walk on the belt to determine if the belt is still slipping. Repeat the above procedure until the walking belt is not slipping. The tension should be just tight enough not to slip.

- ◆ Turning the hex key counter clockwise brings the rear rollers and belt towards you.
- ◆ Turning the hex key clockwise pushes the rear roller and belt away from you.

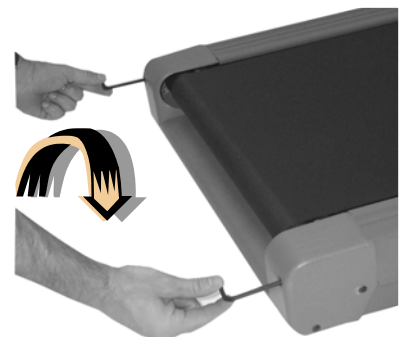

# Change Miles per hour to Kilometers per hour



Your treadmill will operate in British Units (miles per hour) or International Units (kilometers per hour). All treadmills are calibrated at the factory for British Units (miles per hour). To change the display to read in kilometers, follow the steps described here:

- 1) Turn power OFF on the console. (Do not unplug treadmill) Attach the magnet safety key to the console.
- 2) Activate the calibration mode switch by inserting the eraser end of a pencil into the opening in the backside of the console (see diagram below).
- 3) Depressing the calibration mode switch ONCE; CL11 should appear in the TIME window.
- 4) Pressing the SPEED +/- button will activate your choice.
- 5) To accept the setting, press the POWER button.





## **Treadmill will not start.**

- 1) Is the **Safety Key** inserted into the treadmill Console?
- 2) Make sure the power cord is plugged into a surge protector, the surge protector is plugged into a properly grounded outlet, and the surge protector is turned on. (Refer to “Power Requirements” on page 8)
- 3) Check the circuit breaker located on the front of the treadmill. If the switch protrudes, it has tripped. Wait five minutes and then press the switch back in.
- 4) Check the house electrical breaker box and the circuit breaker for the room where the treadmill is located. If it has tripped, reset or have an electrician replace the breaker in home.
- 5) Have an electrician check for inadequate voltage at the outlet.

## **Treadmill loses power during use.**

- 1) Check the circuit breaker located on the front of the treadmill. If the switch protrudes, it has tripped. Wait five minutes and then press the switch back in.
- 2) Check the house electrical breaker box and the circuit breaker for the room where the treadmill is located. If it has tripped, reset or have an electrician replace the breaker in home.
- 3) If the treadmill still will not operate, please call Keys Technical Service at (888) 340-0482.

## **Treadmill walking belt slows during use.**

- 1) Check to make sure the treadmill is securely plugged into an UL-listed surge protector, rated at 15 amps, with a 14-gauge cord of five feet or less and the surge protector is securely plugged into the outlet.
- 2) If treadmill still will not operate, please call Keys Technical Service at (888) 340-0482.

## **Treadmill walking belt slips or is not centered on rear roller.**

- 1) Refer to “Belt Adjustment and Tension” section on page 15.
- 2) Need help? Call Keys Technical Service at (888) 340-0482.

## **Treadmill Error Messages.**

Your treadmill is equipped with a software package that enables error messages to be displayed when there is a problem. **To avoid possible damage to the treadmill and the possibility of injury, do not operate the treadmill until the problem is corrected. Call Keys Technical Service at (888) 340-0482.**

	Part #		Part #		
1	Left Side Extrusion Rail	05-0031	12	Front Wheel (2)	06-0039
2	Right Side Extrusion Rail	05-0031	13	Uprights for Console (2)	various
3	Treadmill Belt	04-0020	14	Motor Hood Cover Top	06-0146
4	Front Roller Assembly	24-0174	15	Motor Drive Belt	04-0004
5	Rear Roller	09-0020	16	Motor	12-0033
6	Treadmill Deck	03-0015	17	Elevation Motor (acuator)	12-0022
7	Left End Cap	06-0143	18	Console Assembly	24-0175
8	Right End Cap	06-0143	19	Membrane	08-0112
9	Rear Adjustable Foot (2)	10-0006	20	Handlebars	various
10	Main Frame	various	21	Toggle switches (2)	08-0027
11	Bottom Motor Pan	06-0145	22	Lower Electronics M/ Control P/Supply	08-0115

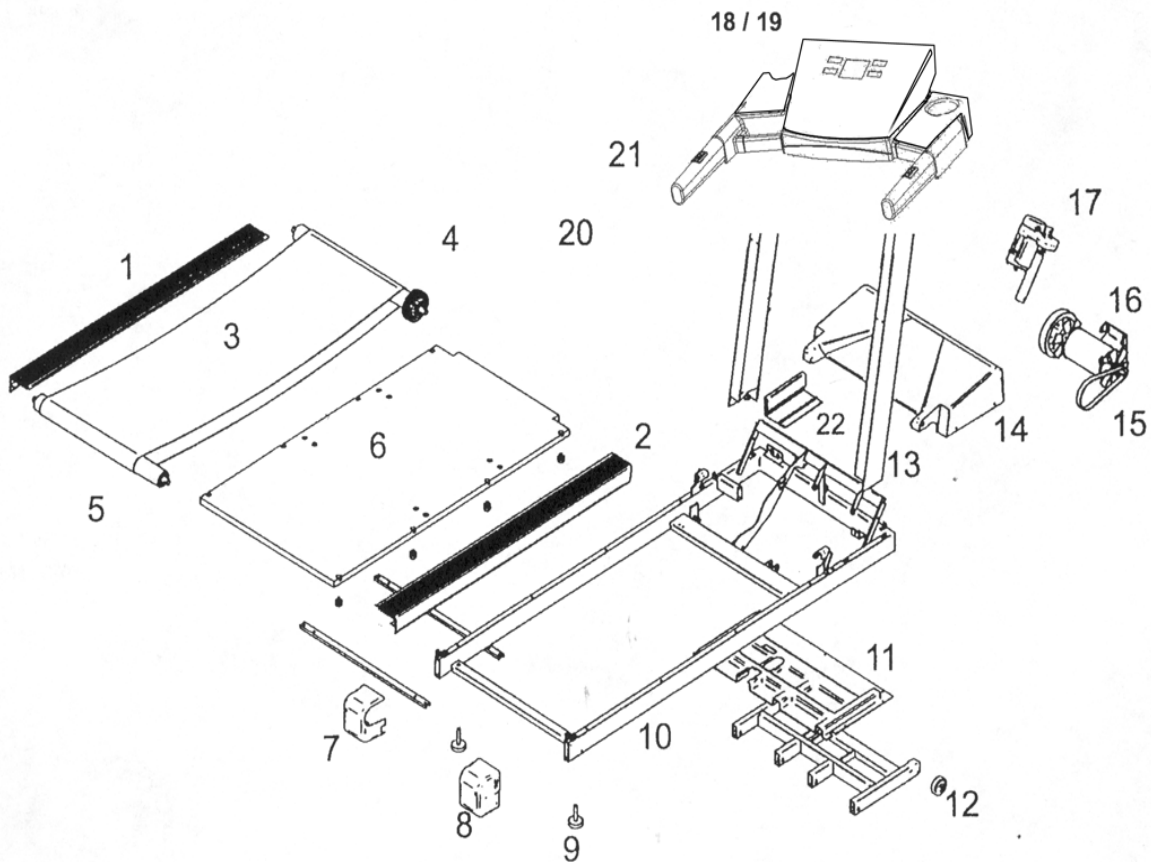

# Milestone 6200HR Parts List



PART #	DESCRIPTION	QTY	PART #	DESCRIPTION	QTY	PART #	DESCRIPTION	QTY
02-0004	SCREW-8x5/8 PHIL PH AB BLACK	24	08-0106	LIMIT SWITCH	1	19-0074	BRKT-ACTUATOR MOUNTING	2
02-0005	SCREW-8x5/8 PPH HILO BLACK TPB	8	08-0112	MEBRANE LED FOR WEDGE CONSOLE	1	19-0076	BRKT-CONTROLLER	1
02-0006	BOLT-HEX 5/16-18x5 1/2 GRADE 5-ZP	1	08-0004	BREAKER-CIRCUIT-15AMP	1	19-0161	PLATE CONSOLE WEDGE	1
02-0007	NUT 5/16-18 NYLOCKZP	3	08-0027	SWITCH-REMOTE-W/HARNESS	2	20-0103	PROC FRAME 17-0074	1
02-0008	BOLT-HEX 5/16-18x3/4 GRADE 2-ZP	3	08-0047	ENCODER-OPTICAL-ALEPH	1	20-0104	PROC RT U/R 17-0061	1
02-0009	NUT-HEX 5/16 WIZ-FL-LK-ZP	3	08-0077	CORE-ERRITE	1	20-0105	PROC LT U/R 17-0061	1
02-0013	WASHER LOCK 1/4"	8	08-0115	CONTROLLER 08-0050 W/OUT SWITCH	1	20-0108	PROC BENT H-BAR 17-0080	2
02-0014	BOLT-HEX 1/4-20x2 1/2" GRADE 5 ZP	9	09-0020	ROLLER REAR 2.5"x24.5" CONV/FOLD	1	21-0048	ACTUATOR X-TB CORNERS CLIPPED	1
02-0015	WASHER SPRING	4	09-0019	FROLLER FRONT 2.5x24.5" CONV	1	21-0049	STIFFNER-NOTCHED	1
02-0016	BOLT-HEX 3/8-16x2 1/2" GRADE 5	1	10-0006	TIP-CRUNCH 1" CNV	2	21-0051	FRAME BRACE PUNCHED	1
02-0017	NUT-NYLOCK HEX 3/8-16	2	10-0017	TAPE-FOAM-1"X75R	1	21-0052	INSIDE 90 DEGREE BEND CTRL BRKT	1
02-0018	NUT-PUSH 3/8 HAT BLACK 375012	2	10-0020	GRIP MOLDED ROUND	2	21-0053	INSIDE CT 17-0079	1
02-0020	SCREW SHCS 1/4-20x2 1/2"	2	10-0023	BOARD ISOLAORS 17/32" SHORT	8	22-0058	ELEVATION BRKT & ROD	2
02-0021	WASHER 9/32 5/8 1/8THICK ZP	2	10-0024	TAPE-ADHESIVE 1'X108" ST567	1	22-0077	ACTUATOR X-TB SUB-ASSEMBY	1
02-0022	NUT-NYLOCK HEX 10-24	4	11-0002	BUSHING-REAR ELEVATION	2	22-0078	U/R SB ASSEMBLY	1
02-0024	CARRIAGE BOLT 5/16x1 GRADE 5 ZP	2	11-0023	FLYWHEEL 1.125 10MPH FOR 2.5 ROLLERS	1	22-0079	DECK FRAME SUB-ASSEMBLY	1
02-0027	NUT-T HF 14209H-DB	8	12-0022	ACTUATOR 40LB-MAYTECH	1	23-0103	FRONT EVEL ASSEMBLY-CONV	1
02-0031	BOLT-HEX 3/8-16x1 3/4" GRADE 5ZP	1	12-0033	MOTOR MCM BLK CHROME 2.5HP	1	23-0104	DECK FRM & REAR LEG ASSEMBLY	1
02-0033	WASHER #10 EXTERNAL STAR	1	13-0003	HARNESS-ENCODE	1	23-0105	U/R ASSEM W/STIFFNER TUBE WEDGE	1
02-0036	SCREW-PPH 8x5/8 GREEN HEAD	1	13-0011	CORD-POWER-90"	1	24-0174	FRONT ROLLER ASSEMBLY	1
02-0038	WRENCH-ALLEN 3/16 SHAFT ARM	2	13-0014	WIRE-JUMPER 12"-220V-KEYS SERIES	1	24-0175	CONSOLE ASSEMBLY MS6200HR	1
02-0040	RETAINER-GUIDE TUBE	1	13-0017	HARNESS-TELCO-HRC	1	26-0085	INST PACKET MS6200HR	1
02-0042	SCREW#8x5/8" SD BLACK	1	13-0042	HARNESS-KILL SWITCH SM9.3	1	15-0108	INST MANUAL MS6200	1
02-0050	NUT-NYLOCK HEX 1/4-20	1	13-0046	HARNESS CONTROLLER 80"	1	16-0070	BOX ASSEMBY MS6200	1
02-0053	SCREW-SHCS 1/4-20x3/4"	2	14-0028	DECAL-CIRCUIT BREAKER ALL	1	07-0027	ELECTRONICS-LCD-4 WIN-HOR-REV	1
02-0054	SCREW-HWH MACH 8-32x3/8"	1	14-0053	DECAL-SINCLINE REMOTE	1	19-0159	BRK MOTOR SUPPORT REVISED 19-0005	2
02-0068	WASHER-FLAT SAE 5/16	2	14-0054	DECAL-SPEED REMOTE	1			
02-0082	SCREW-BUTTON HEAD 5/16-18x2 1/2'	2	14-0205	DECAL DISCONNECT-MOTOR COVER	1			
02-0092	SCREW-PHTR #8x3/7" AB BLACK	7	14-0289	STICKER HEART RATE ACUMEN	1			
02-0099	WASHER -SFW 3/8X7/8X1/8" THICK	1	14-0321	DECAL-10YR MOTOR WARRANTY	1			
02-0103	BOLT-CARRIAGE 10-24x3/4"	4	14-0327	OVERLAY CONSOLE MS6200HR	1			
02-0105	INDRTY-5/16-18 HEAVY WAL AVK	2	14-0337	DECAL MOTOR COVER MS4200/6200	1			
02-0113	SCREW-HWH SLOTTED 8-18x3/4" AB ZP	1	14-0347	DECAL OPERATION WEDGE CONSOLE	1			
02-0123	WASHER-FENDER 1/4x1"	1	14-0356	STICKER 2.5HP	1			
02-0133	NUT RIV 5/16-18 AVAKALS4-518-150		17-0073	RECT 1x2x12GAx24.5	1			
02-0136	TETHER KILL PIN	1	17-0030	RECT 1x1x18GAx3 PUNCHED	2			
02-0137	PLUG PUSH-IN	2	17-0061	RECT 11/2x4x16GAx42 3/4"	2			
02-0140	SCREW PPH#4x5/8" TYPE AB	2	17-0074	RECT 1x3x16GAx165	1			
02-0141	PUSH NUT BLACK.112 SHAFT	6	17-0075	SQ 1x1x18GAx25.44	1			
03-0015	WALKBOARD KORETRON 60"CONV	1	17-0076	RECT 1x2x14GAx25.44	1			
04-0004	BELT POLY V-190J8	1	17-0077	RECT 1x3x16GAx28.44	1			
04-0020	WALKBELT IPLY 19.75x122.75 CONV	1	17-0079	RND 0.5x18GAx100(CUT 32PCS)	1			
05-0031	EXTRUSION LT&RT SIDE BRD CONV GRAY	2	17-0080	RND 1.5x16GAx19H-BAR	2			
06-0014	BUSHING-STRAIN RELIEF #1237	1	18-0008	ROD 3/8x1 1/2"	1			
06-0016	TIES-WIRE	11	19-0184	BRKT HEART RATE REC FOR WEDGE	1			
06-0145	PAN-END-BASE	1	19-0015	BRACKET-MOTOR COVER	7			
06-0021	CLAMP WIRE 3367 7/16	1	19-0019	GUIDE BELT GLAVANIZED	2			
06-0024	CLIP-ALLEN WRENCH	2	19-0023	BRKT-UNIVERSAL	2			
06-0039	WHEEL-KEYS SERIES-2.5"	2	19-0177	BRKT CHANNEL SUPPORTS	2			
06-0058	SUPPORT PC BOARD-HRC	4	19-0106	BRK-LOWER ELEV GUSSET	2			
06-0071	FAN 5"-5/8" ID	2	19-0134	BRACKET-BASE ELEVATION	1			
06-0084	BAG-PLASTIC 12x12 3MIL-INST PACKET	1	19-0147	BRKT FRONT ELEV-REWORK 19-0075	1			
06-0117	SWITC HOUSING ROUND GRAY	2	19-0187	BRKT FRONT ELEV REVISED	1			
06-0139	TETHER HOUSING FOR WEDGE CONSLE	1	19-0105	BRKT-REAR LEG COVER	2			
06-0140	INSERT LED FOR CONSOLE	1	19-0159	BRKT MTOR SUPPORT REVISED 19-0005	2			
06-0142	CONSOLE WEDGE GRAY	1	19-0007	BRKT-MTOR TENSION	1			
06-0143	END CAP DUAL GRAY	1	19-0073	BRKT-ELEVATION PIVOT	2			
06-0144	PULLEY DRIVE 2.5" 8 GROOVE	1	19-0077	BRACE-CNTROLLER FRONT ELEVATION	1			
06-0145	BOTTOM PAN CONV	1	19-0079	BRKT-BELT GUIDE	2			
06-0146	COVER FRO MOTOR CONV GRAY	1	19-0143	BRKT-LEFT STRAIGHT U/R	1			
07-0020	RECEIVER DISCRETE-LED-HRC	1	19-0144	BRKT RIGHT STRAIGHT U/R	1			
07-0050	ELECTRONICS 5 WIN LED GREEN	1	19-0155	BRKT FRON RLLER 2 1/2	2			
07-0041	CHEST STRAP NO LOGO ALL HR UNITS	1	19-0156	BRKT REAR OLLER 2 1/2	2			

**Keys Milestone 6200HR Treadmill KEYS FITNESS PRODUCTS, LP – LIMITED WARRANTY**

**PLEASE CONSULT YOUR PHYSICIAN BEFORE USING THIS PRODUCT.**

This Limited Warranty applies in the United States and Canada to products manufactured or distributed by Keys Fitness Products, LP ("Keys") under the KEYS brand name. The warranty period on the MILESTONE 6200HR to the original purchaser is (lifetime) on the frame, (10) years on the motor, (2) years parts, and (1) year labor.

Keys warrants that the Product you have purchased for non-commercial, personal, family, or household use from Keys or from an authorized Keys reseller is free from defects in materials or workmanship under normal use during the warranty period. Your sales receipt, showing the date of purchase of the Product, is your proof of the date of purchase. This warranty only extends to you, the original purchaser. It is not transferable to anyone who subsequently purchases the Product from you. It excludes expendable parts. This Limited Warranty becomes VALID ONLY if the treadmill is assembled/installed by a Keys Fitness authorized dealer/technician unless otherwise authorized by Keys Fitness in writing (if anyone other than a Keys Fitness authorized dealer/technician assembles a Keys Fitness treadmill the warranty will be void unless accompanied by written authorization by Keys Fitness).

During the warranty period Keys will at no additional charge, repair or replace (at Keys' option) the product if it becomes defective, malfunctions, or otherwise fails to conform with this Limited Warranty under normal non-commercial, personal, family or household use. In repairing the Product, Keys may replace defective parts, or at the option of Keys, serviceable used parts that are equivalent to new parts in performance. All exchanged parts and Products replaced under this warranty will become the property of Keys. Keys reserves the right to change manufacturers of any part to cover any existing warranty.

To obtain warranty service, you must contact a Keys authorized service technician or Keys Fitness at our phone numbers located in this manual. Any parts determined to be defective must be returned to Keys to obtain warranty service. You must prepay any shipping charges, export taxes, custom duties and taxes, or any other charges associated with transportation of the parts or Product. In addition, you are responsible for insuring any parts or Product shipped or returned. You assume the risk of loss during shipment. You must present Keys with proof-of-purchase documents (including the date of purchase). Any evidence of alteration, erasing or forgery of proof-of-purchase documents will be cause to void this Limited Warranty.

This warranty does not extend to any product not purchased from Keys or from an authorized Keys reseller. This Limited Warranty does not extend to any Product that has been damaged or rendered defective; (a) as a result of accident, misuse, or abuse; (b) by the use of parts not manufactured or sold by Keys; (c) by modification of the Product or normal wear and tear; (d) operation on incorrect power supplies; or (e) as a result of service by anyone other than Keys, or an authorized Keys warranty service provider. Product on which the serial number has been defaced or removed is not eligible for warranty service. Should any Product be submitted for warranty service be found ineligible therefore, an estimate of repair cost will furnished and the repair will be made if requested by you upon Keys' receipt of payment or acceptable arrangements for payment.

EXCEPT AS EXPRESSLY SET FORTH IN THIS WARRANTY, KEYS MAKES NO OTHER WARRANTIES, EXPRESSED OR IMPLIED, INCLUDING ANY IMPLIED WARRANTIES OF MERCHANTABILITY AND FITNESS FOR A PARTICULAR PURPOSE. KEYS EXPRESSLY DISCLAIMS ALL WARRANTIES NOT STATED IN THIS LIMITED WARRANTY. ANY IMPLIED WARRANTIES THAT MAY BE IMPOSED BY LAW ARE LIMITED TO THE TERMS OF THIS LIMITED WARRANTY. NEITHER KEYS NOR ANY OF ITS AFFILIATES SHALL BE RESPONSIBLE FOR INCIDENTAL OR CONSEQUENTIAL DAMAGES. SOME STATES DO NOT ALLOW LIMITATIONS ON HOW LONG AN IMPLIED WARRANTY LASTS OR THE EXCLUSION OR LIMITATION OF INCIDENTAL OR CONSEQUENTIAL DAMAGES, SO THE ABOVE LIMITATIONS OR EXCLUSION MAY NOT APPLY TO YOU. This Limited Warranty gives you specific legal rights and you may also have other rights that may vary from state to state. This is the only express warranty applicable to Keys-branded products. Keys neither assumes nor authorizes anyone to assume for it any other express warranty.

PLEASE SEND IN THE ATTACHED WARRANTY CARD WITHIN TEN (10) DAYS OF PURCHASE TO REGISTER YOUR TREADMILL WITH KEYS FITNESS PRODUCTS, LP. MADE IN THE USA. **Thank you for your business!** PLEASE MAIL WARRANTY CARD TO: KEYS FITNESS PRODUCTS, PO BOX 551239, DALLAS, TX 75355.

<b>KEYS FITNESS TREADMILL WARRANTY REGISTRATION</b>			<b>TELEPHONE</b>	
FIRST			M.I.	
LAST				
ADDRESS			APT. NO.	
CITY			STATE ZIP	
DATE OF PURCHASE		MODEL NO.		SERIAL NO.
Where did you learn about treadmills? TV _____ Radio _____ Friend _____		How important are each feature:		Other Comments: _____ _____ _____
In Store Display _____ Salesperson _____		Least Most		
Print ad/flyer _____ Internet _____		Unique Features [ ] [ ] [ ] [ ] [ ] [ ] [ ] [ ] [ ] [ ]		
Why did you purchase a treadmill? Dr.'s Orders _____ Loose Weight _____ In-home convenience _____ Improve Cardiovascular Fitness _____ Safety from outdoors _____		Horsepower [ ] [ ] [ ] [ ] [ ] [ ] [ ] [ ] [ ] [ ]		
Name of store or company where purchased:		Warranty [ ] [ ] [ ] [ ] [ ] [ ] [ ] [ ] [ ] [ ]		KEYS FITNESS respects the rights of your privacy. Our company will not sell or distribute to others the information above. This information is used to track our product quality and to contact you in the event of a product safety concern. It may be used to offer you future Keys products only through the mail. Please check here if wish not to receive any additional information on Keys products. [ ]
How do you plan to use the treadmill? Walk _____ Run _____ Both _____		Price [ ] [ ] [ ] [ ] [ ] [ ] [ ] [ ] [ ] [ ]		
Who will use the treadmill? Male _____ Female _____ Both _____		Look/Design [ ] [ ] [ ] [ ] [ ] [ ] [ ] [ ] [ ] [ ]		
How many family members? _____		Folding Feature [ ] [ ] [ ] [ ] [ ] [ ] [ ] [ ] [ ] [ ]		
AGE: 15-24 _____ 25-34 _____ 35-44 _____ 45-54 _____ 55-64 _____ 65 + _____		Safety from outdoors _____		
		Other _____		